



# Dry Compression Rotary Screw Compressors

## CSG Series

With the world-renowned **SIGMA PROFILE** ⚙️

Flow rate up to 15 m<sup>3</sup>/min, Pressure up to 11 bar

[www.kaeser.com](http://www.kaeser.com)

CSG series

## To better classes in purity and efficiency

Two-stage dry compression rotary screw compressors from KAESER not only impress with their intelligent component layout, but also with their many innovative details – all of course with the renowned KAESER quality and distinctive, contemporary design.

Whether for the semiconductor, food or automotive industries, our two-stage dry-running compressors tirelessly prove that process-appropriate purity and cost-effectiveness truly can go hand in hand – even under adverse conditions.

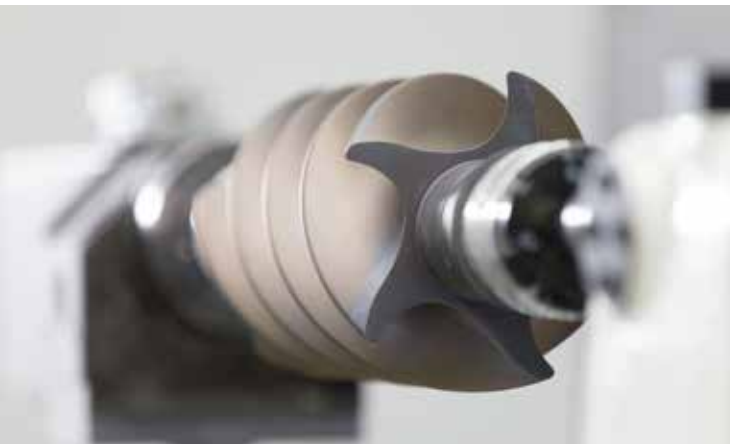

### Long-term efficiency

Compressed air simply has to be available whenever it is needed. To ensure that this remains the case over many years to come, production and assembly processes have to be repeatable and reproducible with high accuracy. Therefore, KAESER relies on an 'Industrie 4.0' production environment with advanced automation and robotics.

### Traceable quality

All functionally relevant components in the compressor airend are 100% traceable in terms of material and manufacturing. This creates transparency, particularly in sensitive production processes.

### Efficient and innovative

In the state-of-the-art research and development centre, KAESER engineers have created a next-generation dry compression rotary screw compressor airend that stands in a class of its own when it comes to purity and efficiency.

### Sustainably optimised

Sustainable compressed air generation, especially in hygienically sensitive processes, requires individual analysis and optimisation. That is why KAESER developed appropriate optimisation software in parallel with the compressor.



## Contents

### Efficiency optimised for your application

Qualification for hygienically sensitive processes .....	04-05
Engineered and made by KAESER .....	06-07
Drive systems on the new CSG series .....	08-09

### Energy savings down to the smallest detail

Air cooling .....	10-11
Water cooling .....	12-13
Service .....	14-15
SIGMA CONTROL 2 .....	16
SIGMA AIR MANAGER 4.0 .....	17
Why recover heat? .....	18-19
Global remote monitoring .....	20
KAESER AIR SERVICE .....	21
The foundations of product development .....	22-23
Technical implementation of integrated heat recovery .....	24-25
Precision analysis essential .....	26-27
Integrated refrigeration drying .....	28-29
Dependable pressure dew points through innovative process engineering ..	30-31
Precision operation for high efficiency and low pressure dew points .....	32-33

### Technical data, equipment and options

Technical data .....	34-37
Equipment .....	38
Options .....	39





Efficiency optimised for your application

## Qualification for hygienically sensitive processes

KAESER's dry compression rotary screw compressors are optimised for the demanding requirements of compressed air supply for production processes inside a clean room – this starts with careful selection of the materials used and ends with precision in the production process.

Specifically, this means that KAESER considers the air flow path of the rotary screw compressors when selecting materials. Therefore, great care is taken to ensure that all components are suitable for use with sensitive production processes.

### Residual oil class 0 to ISO 8573-1

In order to meet your specific requirements, KAESER includes every one of your production processes in the design procedure, from development through to commissioning.

The risk of potential product contamination by the rotary screw compressor is evaluated and minimised by means of an HACCP analysis.

Our diligence is confirmed by the TÜV in the form of a residual oil class 0 certificate in accordance with ISO 8573-1.

Absolute transparency is of the utmost importance to KAESER. Therefore, all functionally relevant components in the compressor airend are 100% traceable. This way, nothing escapes our attention – not even the smallest error.

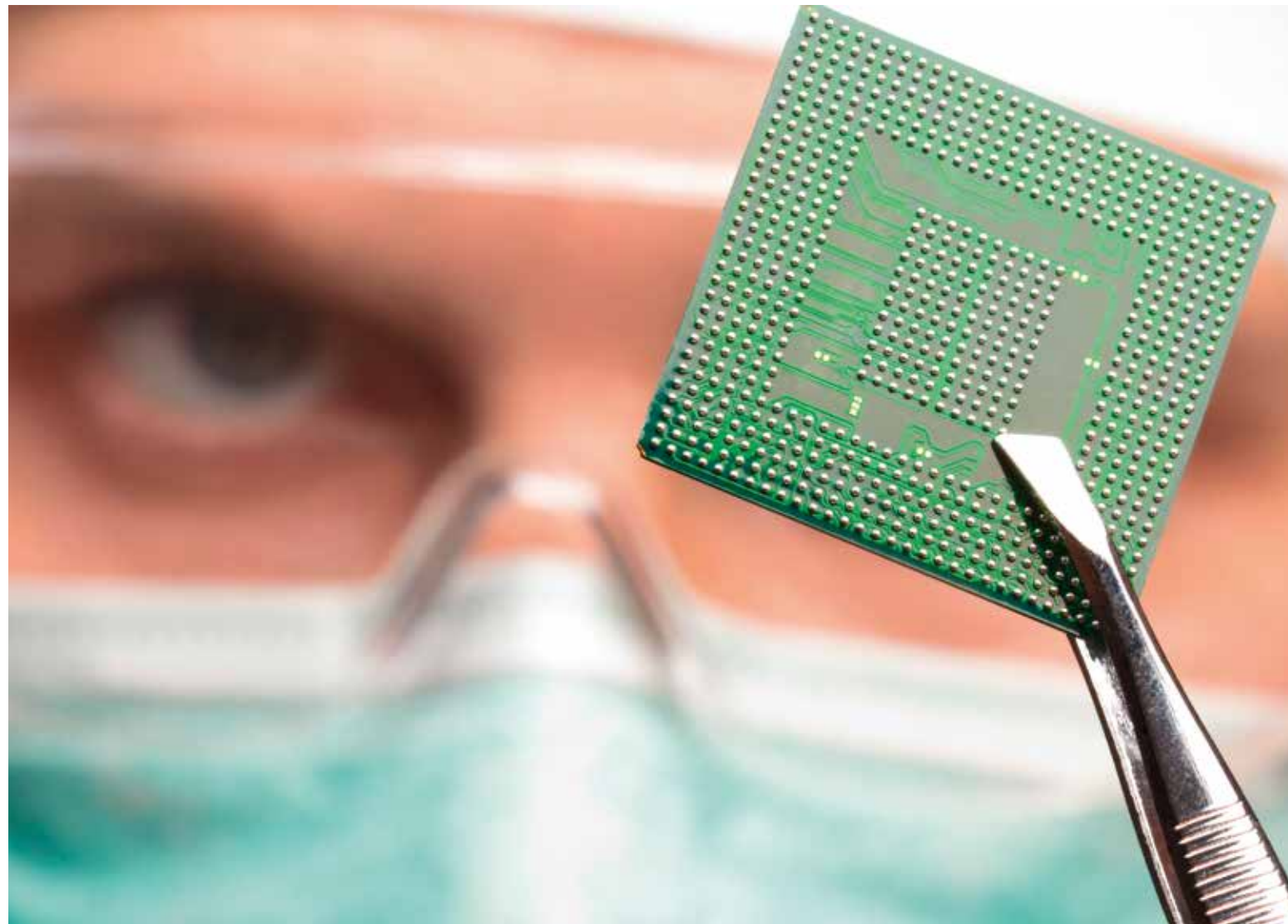

### We support your validation

Both KAESER's dry compression rotary screw compressors and the air treatment components are networked via the tamper-proof KAESER SIGMA NETWORK.

With the help of the SIGMA AIR MANAGER 4.0 master controller, process data can be collected, evaluated, and made available as a report.

Your process validation has never been so easy.





Rotary screw airend with SIGMA PROFILE

## Engineered and made by KAESER

The newly developed rotary screw compressor airend for CSG systems is revolutionary. Dry compression rotary screw compressors with the SIGMA PROFILE are streets ahead when it comes to both compressed air purity and efficiency.

### Innovative PEEK coating

The rotary screw compressor airend is equipped with a highly durable PEEK coating. This coating is made of the high-performance plastic polyetheretherketone, which is double heat treated at over 400 °C and is therefore highly temperature-stable. The coating has outstanding abrasion resistance and strong non-stick characteristics, making it ideal for use in the food and pharmaceuticals industries.

The innovative PEEK coating is biocompatible and water-based to ensure excellent environmental compatibility and sustainability.

### Efficiency in every component

Integrated water and oil lines ensure reliable operation of the dry compression rotary screw compressor airend, as well as preventing leaks. Moreover, the purge air system prevents leakage air losses, further maximising efficiency.



### KAESER SIGMA PROFILE

At the heart of every CSG system lies a premium-quality airend featuring KAESER's SIGMA PROFILE rotors. Flow-optimised and robustly constructed, this combines maximum energy efficiency with sustainable durability.



### Coating made by KAESER

The rotors and housing on the dry compression rotary screw compressor airend are equipped with a special coating developed in-house, which consists of three layers: nanoceramic, PEEK basecoat and topcoat. Not only is this exceptionally durable, but also food-safe, as certified by the FDA and EU regulation 1935.



### Easy maintenance thanks to access openings

In addition to efficiency, ease of maintenance was a top priority from the very outset of the rotary screw compressor airend development process. Innovative mould inclines in the casting enable easy cleaning of the airend. This minimises the duration of gear oil changes and maximises the service life of fresh oil, thanks to the lower residual oil content during oil changes.



### Water jacket cooling

Water jacket cooling ensures optimal operating temperatures in the first and second compression stages. Efficiency is significantly increased during compression thanks to the maximised cooling surface area. Furthermore, integration of the water lines ensures reliable leak prevention.

CSG series

## Drive systems on the new CSG series

### Fixed speed, fixed flow rate.

#### CSG base load

Base load compressors from KAESER are designed to run at one optimal operating speed. Operating at maximum efficiency, they deliver a constant air volume at a fixed motor speed, making them ideally suited for applications with a constant or lightly fluctuating air demand.

#### Committed to meeting your objectives

CSG base load compressors stand out for their functional, durable drive technology and supreme levels of efficiency.



#### Super Premium Efficiency IE4

When it comes to base load compressors, SUPER PREMIUM EFFICIENCY IE4 asynchronous motors guarantee best possible efficiency, thanks to their well-proven, durable technology and renowned service-friendliness.

### Variable speed, variable flow rate.

#### CSG peak load

Maximum flexibility and sustainability: thanks to their variable-speed drive motors, CSG peak load compressors from KAESER always deliver the exact volume of compressed air that is actually required. This makes them particularly efficient in applications with variable air demand.

#### Committed to meeting your objectives

CSG peak load compressors stand out for their extremely high levels of flexibility when it comes to air delivery volumes. Fitted with synchronous reluctance motors, they guarantee a high level of efficiency across the whole air delivery range.



#### Perfect teamwork - IES2

In the case of compressors with variable speed control, the motor and frequency converter must work together in harmony in order to operate efficiently. For this reason, KAESER selects IE5 efficiency class SIEMENS reluctance motors with specifically matched frequency converters to ensure perfect interplay and highest system efficiency - IES 2.



#### Resource-conserving and service-friendly

The synchronous reluctance motors fitted by KAESER are constructed to conserve resources. Specially formed magnetic steel sheets replace aluminium, copper and expensive rare earth materials. This makes the drive not only highly durable, but also service-friendly.



#### Efficient and economical

Synchronous reluctance motors deliver high efficiency levels throughout their entire speed range. This helps to save both energy and costs, even during partial load operation.





CSG series

## Air cooling

Dependable performance – even under extreme conditions

**The benefits:**

Variable cooling air flow – enhances efficiency

Water jacket cooling – enhances efficiency, ensures dependable operation at high ambient temperatures

◀ Image: CSG 150 A



### Water jacket cooling

The effective water jacket cooling achieves an efficiency increase of several percentage points in comparison to oil jacket cooling. Moreover, the service life of the gear oil is increased to 18,000 operating hours.



### Variable cooling air flow rate

Thanks to the innovative fan system, cooling air flow is regulated as needed. This enables optimal adjustment to the corresponding load situation and cooling air temperature.



### Continuous operation at 45 °C

Air-cooled CSG machines operate dependably in ambient temperatures up to +45 °C, thanks to their durable and energy-efficient radial fan.



CSG series

# Water cooling

Compact energy-savers

**The benefits:**

Variable cooling water flow – enhances efficiency

Increased cooling surface area – enhances efficiency, ensures low discharge temperatures

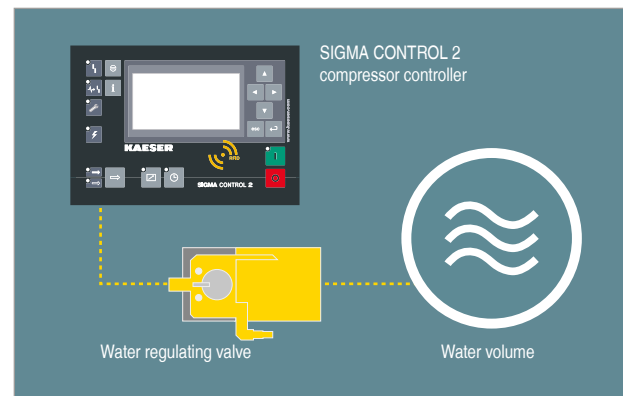

Image: CSG 120-2 RD W SFC ▶



## Parallel flow

Flow through the air coolers in the first and second stages is performed in parallel to assure optimal operating temperatures. The same respective inlet temperature ensures significantly increased overall efficiency.



## Optimum cooling water flow

Water-cooled CSG compressors are equipped with water regulating valves downstream from each heat exchanger. This way, each consumer receives the optimal amount of water, resulting in an economical and therefore sustainable use of cooling water. In addition, KAESER uses regulating valves at the water outlet that are airtight when closed. If the compressor does not require cooling, for example in standby operation, the water flow is stopped and waste is avoided.

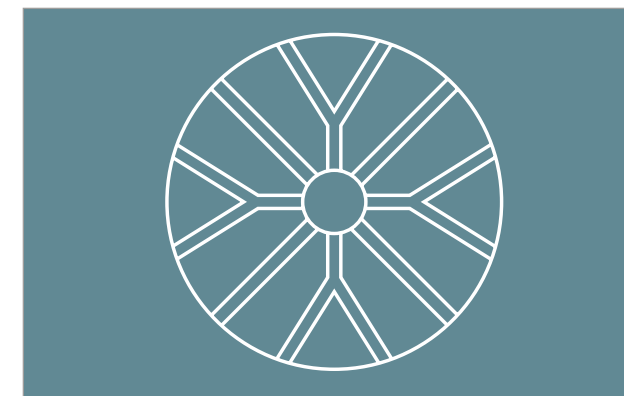

## Innovative snowflake profile

For perfect cooling, all air-carrying pipes in the stage 1 and 2 process air coolers are equipped with the innovative snowflake profile, which offers a number of advantages: The profile has a 46% higher heat transfer area, allowing for a 10% reduction in heat exchanger length and a 19% reduction in compressor footprint.



## Optimised cooler flow

The flow-optimised air inlet and outlet ensure significantly reduced pressure loss. In addition, the cooler air flow path is made of hygienic stainless steel.

# Service...

## ...virtually maintenance-free



### (1) Pulsation dampers

Thanks to an effective combination of a chamber silencer and Venturi nozzle, KAESER's newly developed, efficient, broadband pulsation dampers keep pressure losses to an absolute minimum and minimise unwanted vibrations. Their fibre-free, and therefore maintenance-free, design reliably eliminates particle contamination from the compressed air. It goes without saying that this coating is suitable for use in the food and pharmaceuticals industries.

### (2) Long-life compressor unit

KAESER's dry compression rotary screw airend is extremely durable. Preventative replacement is not required. The standard-equipped vibration monitoring ensures reliable operation.

## ...excellent accessibility



### (3) Increased motor availability

In order to ensure that CSG systems operate dependably, their motors are equipped with motor bearings featuring automatic lubrication. To prevent motor damage, the motor bearing and winding temperatures are monitored.



### (4) Easy-care inlet valve

The pneumatically operated inlet valve in KAESER dry compression rotary screw compressors is unaffected by contaminants and condensate. Thanks to its robust mechanics, it is reliable and easy to maintain. Therefore, service is only required after 18,000 operating hours. The coating is suitable for use in the food and pharmaceuticals industries.



Image: CSG 150 W SFC i.HOC



Image: CSG 150 W SFC i.HOC



SIGMA CONTROL 2 internal compressor controller

## SIGMA CONTROL 2

The integrated SIGMA CONTROL 2 controller coordinates compressed air generation and ensures efficient, reliable machine operation. Moreover, it guarantees perfect interaction within the integrated system as a whole. All relevant components and operating states are monitored and evaluated – messages are available to the operator for evaluation directly on the controller display, or simply and conveniently from any desk via the integrated web server. A multitude of communications functions are available, including the option of connecting the machine to a SCADA central control system, meaning that you can stay connected in any eventuality.



SIGMA AIR MANAGER 4.0 compressed air management system

## SIGMA AIR MANAGER 4.0

Adaptive, efficient and networked – demand-oriented compressed air management takes on a whole new meaning with the SIGMA AIR MANAGER 4.0. This advanced master controller coordinates operation of multiple compressors, as well as dryers or filters, with exceptional efficiency. A patented, simulation-based optimisation process determines future demand based on past compressed air consumption profiles. Thanks to networking of all components in the compressed air station via this intelligent master controller and the secure KAESER SIGMA NETWORK, comprehensive monitoring, energy management and predictive maintenance are all possible.



### Efficient thermal management

For durable compressor operation, well-balanced thermal management of the compressor is required. SIGMA CONTROL 2 processes the necessary sensor and actuator information in order to regulate cooling performance as needed. Fan speed is varied on air-cooled compressors, whilst on water-cooled compressors, the cooling water volume is individually adjusted for each heat exchanger.



### Dependable condensate separation

Thanks to its flow-optimised design, the efficient axial centrifugal separator reliably separates accumulating condensate downstream from the air coolers – with minimal pressure loss. The integrated SIGMA CONTROL 2 compressor controller ensures dependable condensate drainage.

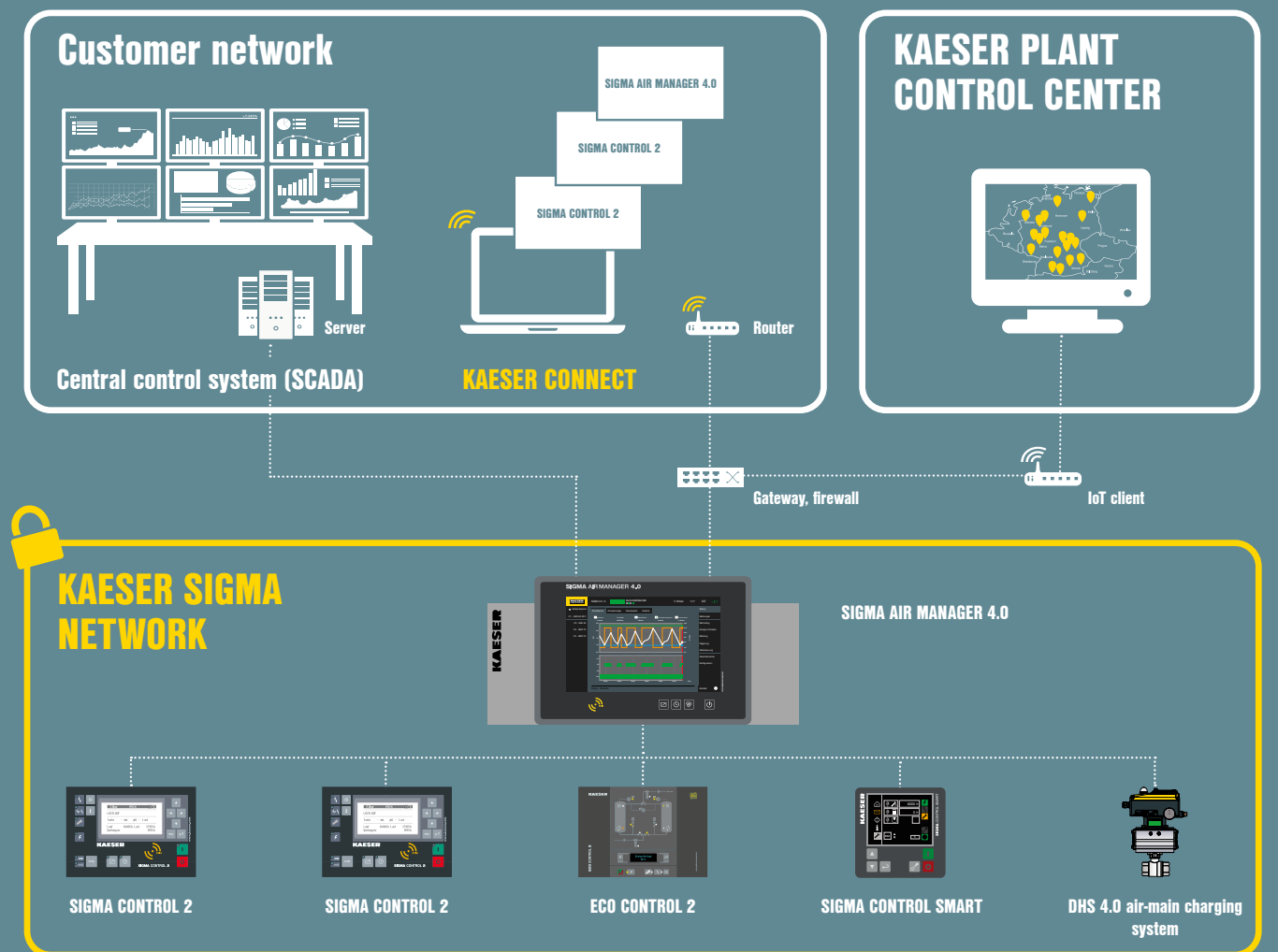

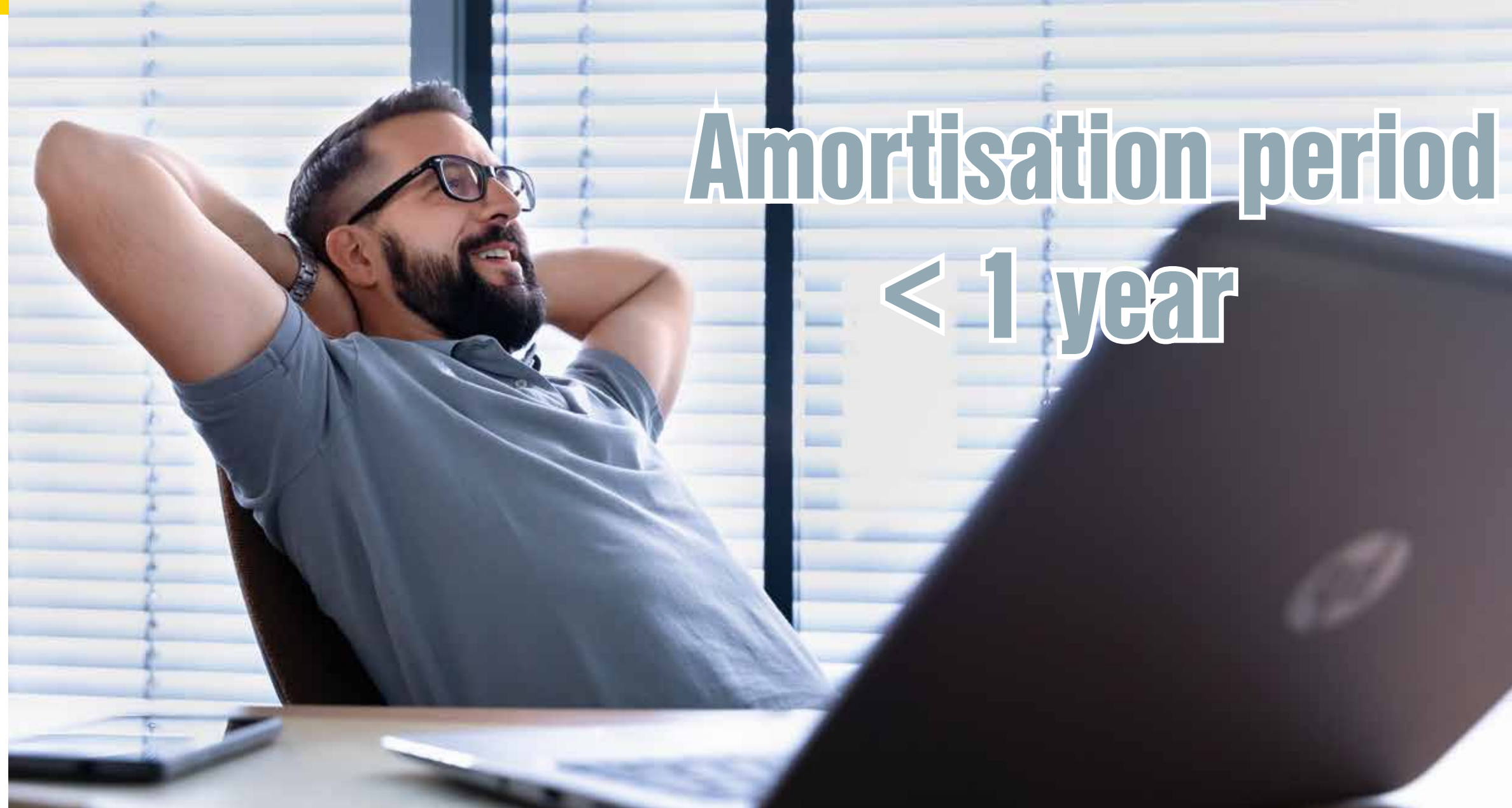

## Why recover heat?

In fact, the question should be: Why not?

You will not only reduce your company's primary energy consumption, but also improve its CO<sub>2</sub> balance.

### Compressors with air cooling

Compressed air users need to develop clever ideas regarding the use of hot exhaust air from their compressors. With our many years of planning experience, we will gladly assist you!

### Compressors with water cooling

Thanks to the compact heat recovery module integrated into the compressor, generating hot water for production or auxiliary heating purposes could not be simpler. Cost- and space-intensive external infrastructure is not necessary with KAESER solutions and the amortisation period of the heat recovery module is usually less than a year (see example calculation below).

Overall power consumption for CSG 150	90 kW
Maximum available heat output (96% of total power consumption)	86.4 kW
Compressor load hours per day	16 h
Heating periods per year	100 days

Savings compared to oil heating	
Calorific value	10.6 kWh/l
Price	€ 1.50/l
CO <sub>2</sub> emissions	2.8 kg CO <sub>2</sub> /l
Heating efficiency	90%
<b>Heating cost saving</b>	<b>€ 21,736 per year</b>
<b>CO<sub>2</sub> saving</b>	<b>40,574 kg CO<sub>2</sub> per year</b>

Savings compared to gas heating	
Calorific value	11 kWh/m <sup>3</sup>
Price	€ 1.20/m <sup>3</sup>
CO <sub>2</sub> emissions	2.0 kg CO <sub>2</sub> /m <sup>3</sup>
Heating efficiency	90%
<b>Heating cost saving</b>	<b>€ 16,756 per year</b>
<b>CO<sub>2</sub> saving</b>	<b>27,927 kg CO<sub>2</sub> per year</b>

### Water-cooled compressors

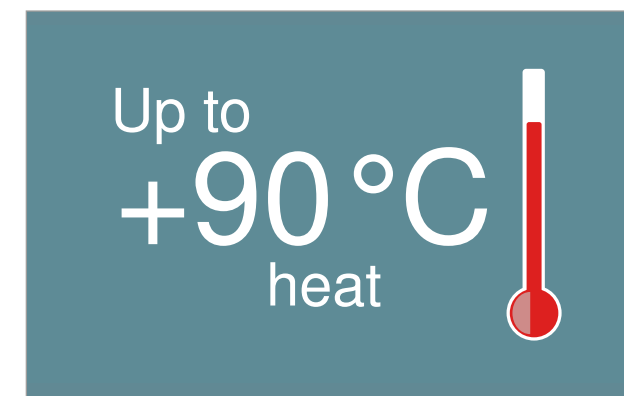

#### Process, heating and service water

Compressor exhaust heat can be used to produce hot water with temperatures up to +90 °C, which can then be used for a wide range of applications in your production process.

### Air-cooled compressors



#### Space heating with hot exhaust air

Heating made simple: Thanks to radial fans with high residual thrust, the reusable (hot) air from air-cooled CSG systems can easily be ducted away to spaces that require heating – and usually without the need for additional fans.



KAIR Console – capturing energy metrics and calculating compressor efficiency

## Global remote monitoring

### Preventive compressor maintenance

In order to allow KAESER AIR SERVICE rapid insight into a compressor's operating state, KAESER offers a modem with the compressor. The SIGMA CONTROL 2 compressor controller transmits operating data to the modem via the KAESER SIGMA NETWORK. The collated data provide you with information regarding system performance trends and any possible deviations. Moreover, the characteristic values can be viewed remotely, downloaded for further analysis and archived for later use. This enables preventive compressor maintenance.

### Maximum, long-lasting efficiency

By enabling preventive maintenance measures, remote monitoring by KAESER guarantees that the compressor's total operating time is maximised throughout its entire service life. Intelligent algorithms ensure that immediate measures are taken in the event of warnings or notifications, thereby providing maximum and long-lasting efficiency.

### Optimise maintenance processes

KAESER's remote monitoring allows you to optimise your maintenance procedures. To enable quick action, all operating data are made available immediately, thereby automating the maintenance process. All stakeholders benefit from the resulting time savings and improved work procedures.

**Sustainability**



**Certification**



**Cost savings**



KAESER AIR SERVICE

## Uncompromising excellence



One of the key requirements for any compressed air supply is maximum availability. To guarantee this on a continuous basis, KAESER AIR SERVICE is always there for you. No matter whether it's performing commissioning, maintenance or repairs, our customer service stands out for its uncompromising excellence. Around the clock. Worldwide.

KAESER AIR SERVICE is there, wherever you need it: all over the world, highly qualified Service Technicians are ready to assist you. Our customer service ensures perfectly executed maintenance and repair work for maximum efficiency. Close proximity ensures a rapid response, which translates into maximum compressed air availability.

KAESER AIR SERVICE ensures a long service life for your compressed air system: perfectly matched service concepts and high-quality, genuine KAESER parts guarantee sustainable operation of your compressed air supply. KAESER service vehicles are stocked with a comprehensive range of maintenance and spare parts, ensuring that many types of repair can be carried out immediately. Should additional parts be required, the advanced logistics centre at the main plant in Coburg will ship the necessary items overnight.

### 24-hour support

Compressed air needs to be available all day, every day, which is why technical support staff, replacement parts and service technicians are on hand 24/7.



Our service number can be found at [www.kaeser.com](http://www.kaeser.com)



## The foundations of product development

KAESER sets new standards when it comes to dependability, efficiency and sustainability. However, we are not satisfied delivering just that. Our products and services are continuously being optimised, with the objective of achieving ever greater energy efficiency, best possible compressed air availability and optimum cost efficiency for our customers. KAESER products are designed not only to be extremely efficient during operation; energy consumption is also minimised as far as possible during the production process. When it comes to our own investments and purchasing, we strive to seek ever more energy-efficient products and services. KAESER's innovations help to reduce energy consumption significantly and to save

operating costs. They also contribute to the preservation of resources and the reduction of emissions. Our energy-efficient solutions help our customers to achieve their own sustainable and environmentally responsible operation. True to the KAESER philosophy of "More compressed air for less energy", our products not only operate extremely cost-efficiently and in the most eco-friendly manner, they also consume as few valuable environmental resources as possible during production, sales and service.

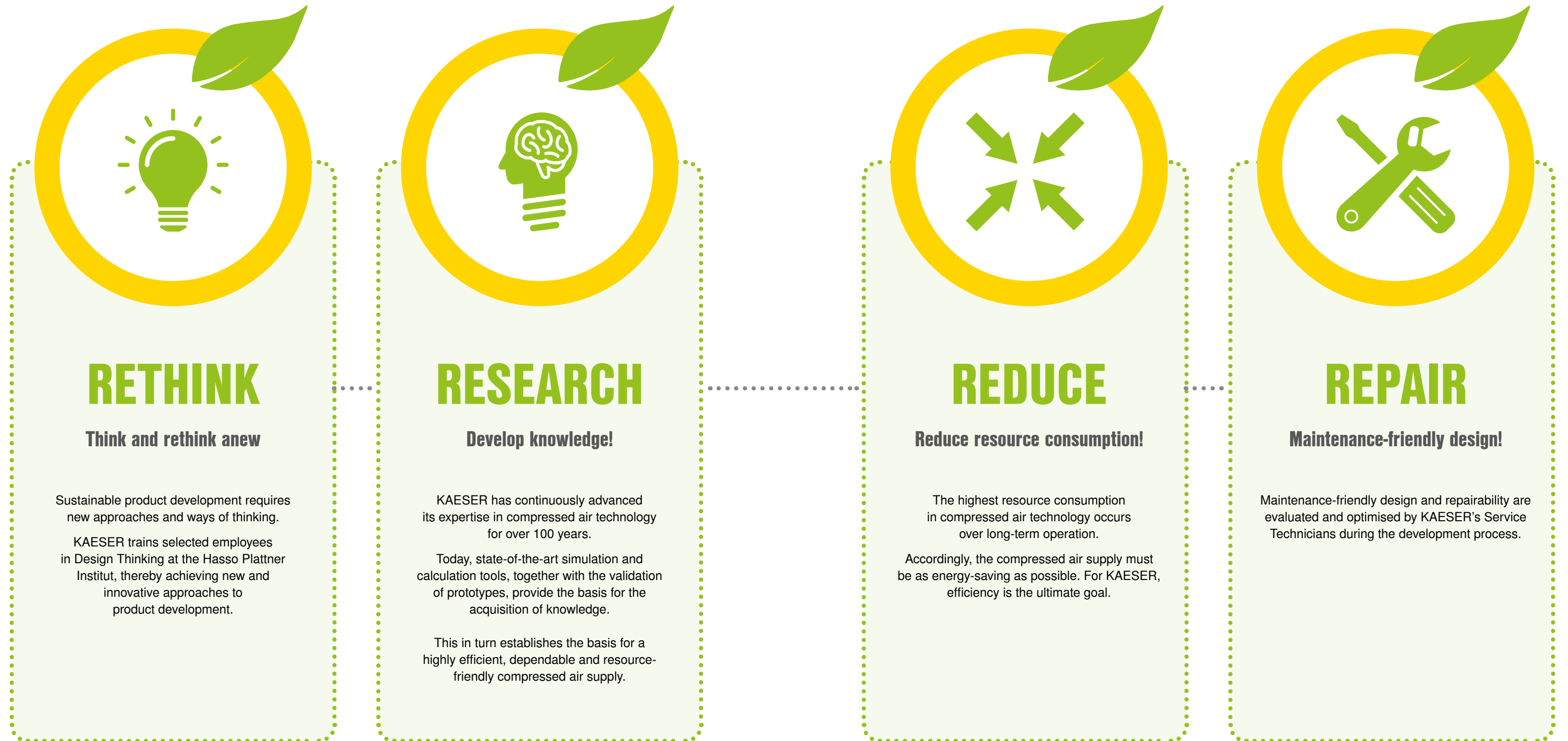



# Technical implementation of integrated heat recovery

CSG – Water-cooled version with heat recovery

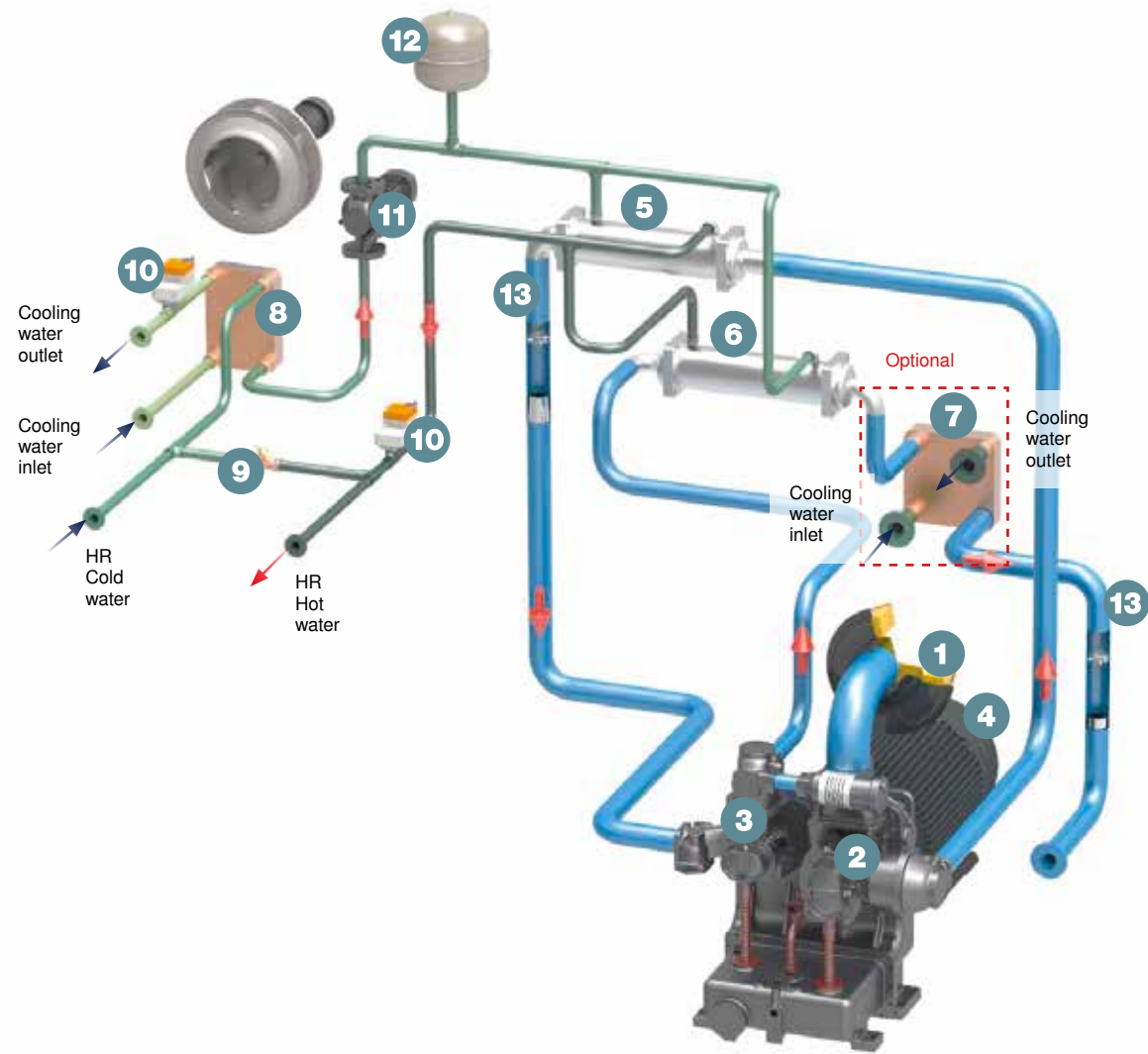

- |  |   |
|--|---|
| (1) Intake filter  | (8) Heat exchanger (water/water)                        |
| (2) Low-pressure stage (stage 1)   | (9) Check valve   |
| (3) High-pressure stage (stage 2)  | (10) Water regulating valve (actuated by SIGMA CONTROL) |
| (4) Drive motor  | (11) Pump   |
| (5) Air cooler downstream from stage 1 (air/water)   | (12) Expansion tank                                     |
| (6) Air cooler downstream from stage 2 (air/water)   | (13) Condensate separator                               |
| (7) Optional additional heat exchanger (air/water)<br>→ Version as plate-type heat exchanger | (14) Integrated i.HOC rotation dryer                    |

In two-stage dry compression rotary screw compressors, some 90% of the usable heat is processed through the two air coolers (5) and (6).

KAESER therefore uses separate, high-quality heat exchangers developed specially to meet heat recovery requirements. This potential can be used for many different situations.



Versions with rotation dryer

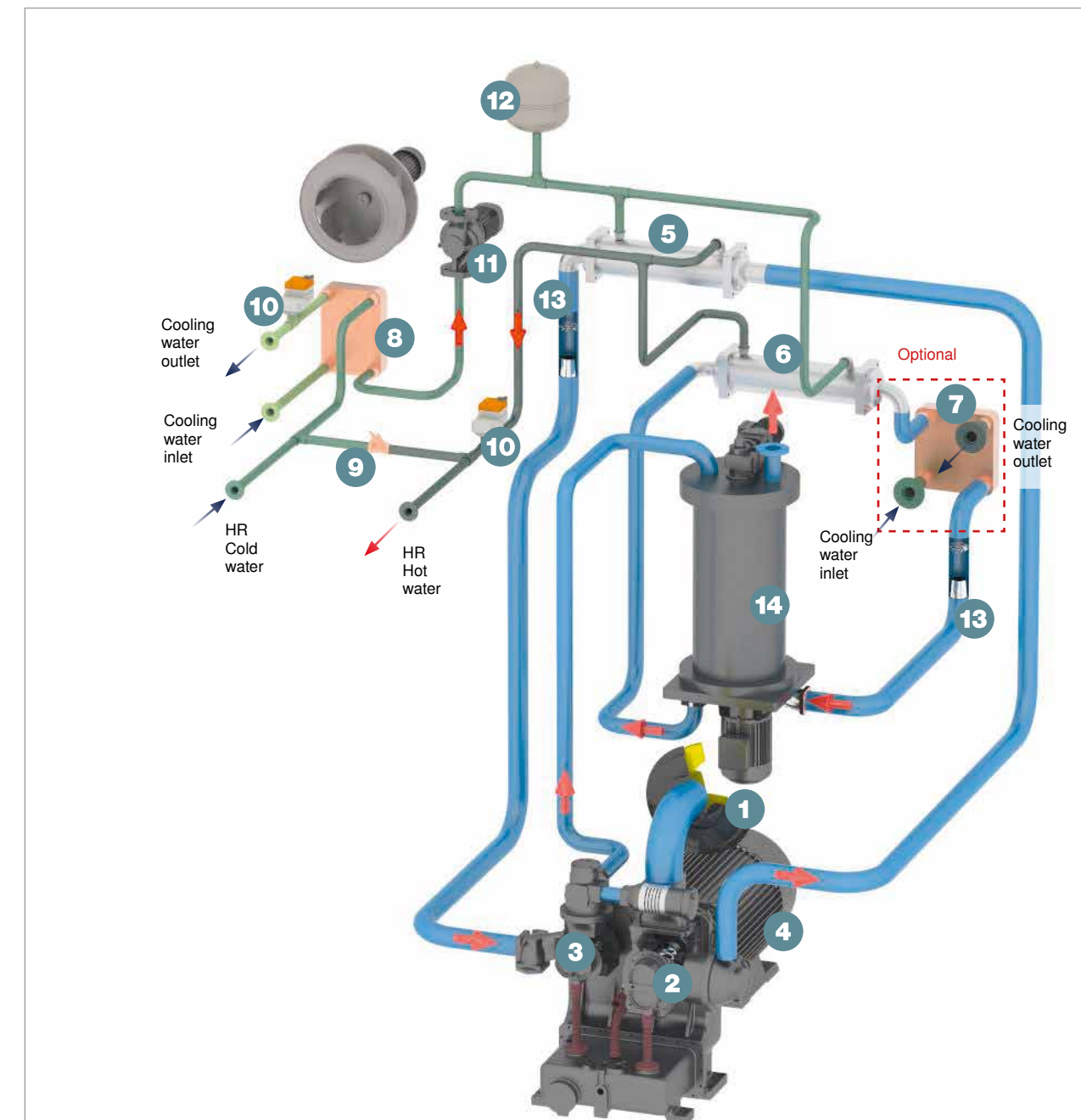

# Compressed air drying process – Overview



+3 °C RMC 4<sup>1)</sup>



Refrigeration dryers



-30 °C RMC 3<sup>1)</sup>



i.HOC rotation dryer



down to -70 °C RMC 2<sup>1)</sup>



CALOSEC heat-regenerating desiccant dryer



below -70 °C RMC 1<sup>1)</sup>



Heatless-regenerating desiccant dryer

<sup>1)</sup> Residual moisture in the compressed air following drying.

<sup>1)</sup> RMC = Residual Moisture Class

# Precision analysis essential

The required pressure dew point plays a significant role in determining the drying process, as well as the investment, service and energy costs associated with compressed air drying. It is therefore highly recommended to carry out a detailed system analysis. Unnecessarily high compressed air volume creates additional costs, which is something that we will gladly help you avoid!



Refrigeration dryer

For oil-free compression rotary screw compressors, refrigeration dryers are the go-to choice for delivering best possible energy efficiency and favourable investment costs when pressure dew points down to +3 °C are required. Pressure dew points below +3 °C are provided by desiccant dryers.



i.HOC rotation dryer

Integrated into the rotary screw compressor, the optional i.HOC rotation dryer can reliably and efficiently deliver pressure dew points down to -30 °C. The hot compressed air from the second compression stage is used to regenerate the desiccant.



CALOSEC heat-regenerating desiccant dryer

CALOSEC heat-regenerating desiccant dryers offer energy-saving solutions for pressure dew points down to -70 °C.



Heatless-regenerating desiccant dryer

DC series heatless-regenerating desiccant dryers from KAESER achieve Class 1 pressure dew points safely, even under extreme operating conditions.



# Integrated refrigeration drying

KAESER refrigeration dryers ensure dry compressed air that is perfectly suited for the intended application and all flow rates. With these high-quality industrial machines, you will be providing reliable protection against condensate damage for your systems and processes, even under the harshest of conditions.



## Energy-saving drying

An integrated design, together with the generously dimensioned aluminium block heat exchanger, helps ensure a minimal pressure loss of less than 0.1 bar. The energy-saving scroll refrigerant compressor helps to achieve additional compressed air energy savings. T-systems are equipped with R-513A refrigerant, which has a very low GWP value. They are future-proof for the entire life cycle of the system.



## Excellent accessibility

All refrigeration dryer components are perfectly accessible via the service door on the side of the unit. This makes dryer servicing and maintenance a breeze.

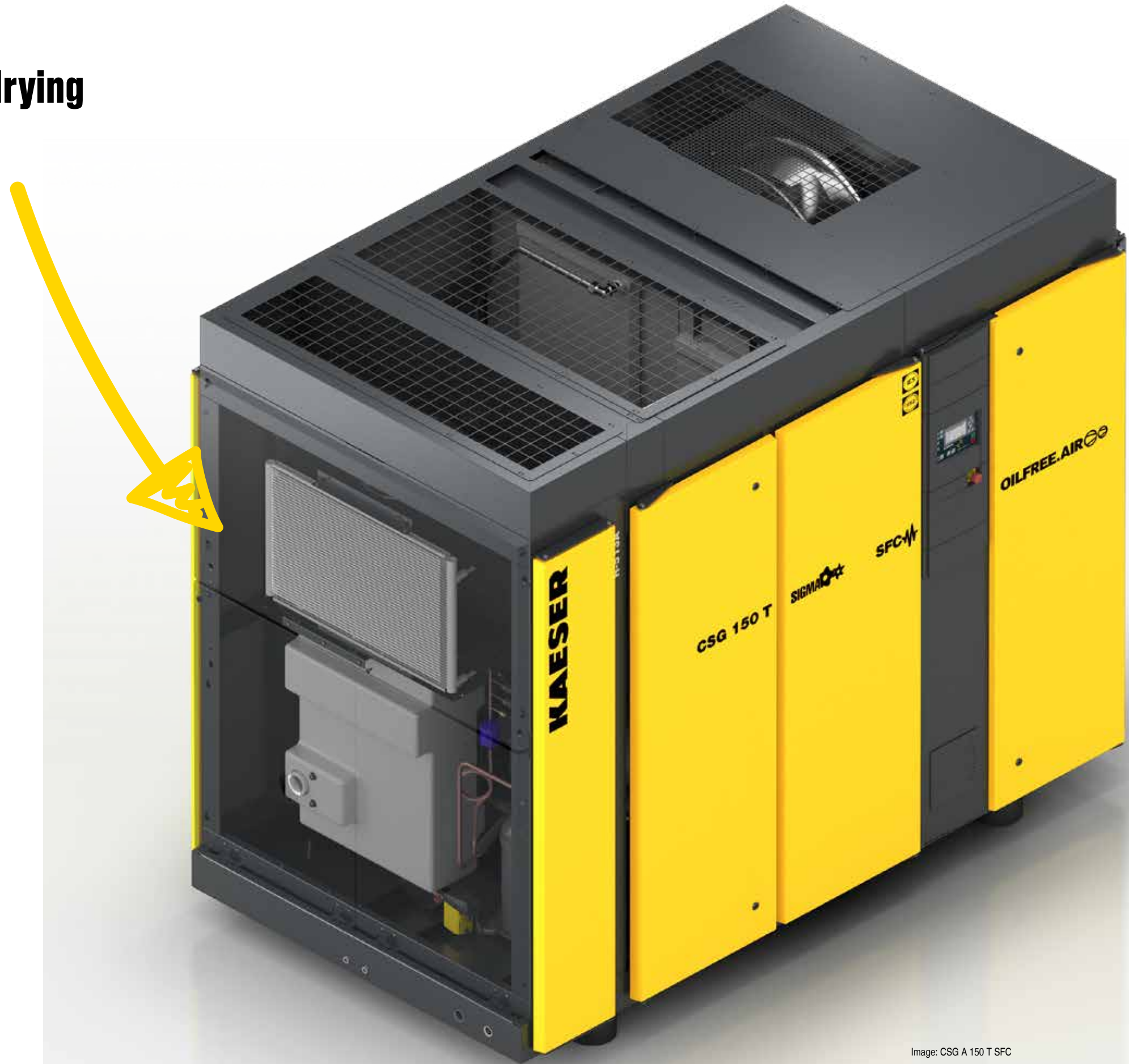

Image: CSG A 150 T SFC

i.HOC

## Dependable pressure dew points thanks to innovative process engineering

The patented i.HOC rotation dryer from KAESER uses 100% of compression heat from the second stage. Thanks to this full-flow regeneration method, these dryers deliver reliable pressure dew points up to an ambient temperature of 45 °C – without any electrical heating or additional cooling of the regeneration air! Air- and water-cooled versions are available.

### The benefits:

- Dependable sub-zero pressure dew points even at high ambient or coolant temperatures
- Pressure dew point sensor for monitoring drying quality integrated as standard
- Pressure dew point stability even at the lowest compressor loads – without any need for a partial load compensator
- Available with pressure dew point control if required
- Highly effective drying and heat recovery on water-cooled compressors



Image: CSG 150 A SFC i.HOC, person shown 1.80m tall

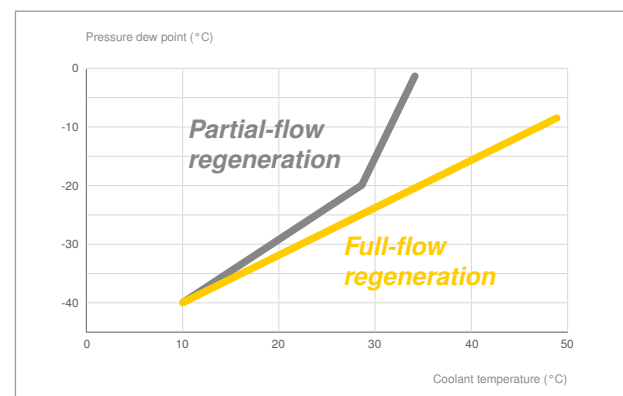
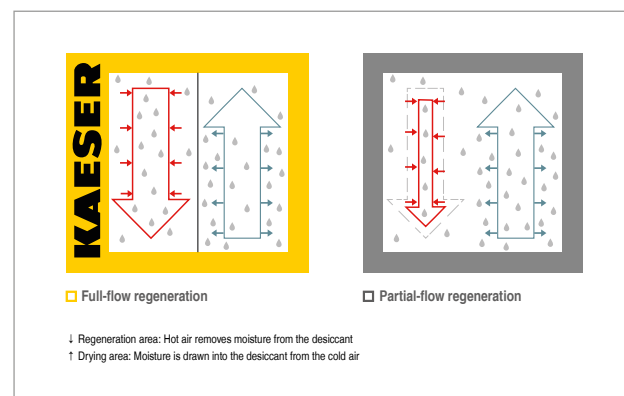

### Full-flow regeneration in detail

The i.HOC (Integrated Heat of Compression Dryer) system uses 100% of the heat of compression from the second compression stage for drying purposes (full-flow regeneration). This heat, which is produced in any case, is therefore effectively available at zero cost.

### Drying even near the limit

The advantages of full-flow regeneration become obvious, especially with increased coolant temperatures. KAESER rotation dryers achieve outstanding drying results, even without additional electrical heating of the regeneration air.



### Perfect performance

The i.HOC rotation dryer's intelligent control ensures pressure dew point stability even with fluctuating flow rates and at partial compressor load. When commissioned, the target pressure dew point is reached after just one rotation of the drum. The standard-equipped pressure dew point sensor continuously monitors compressed air drying quality.

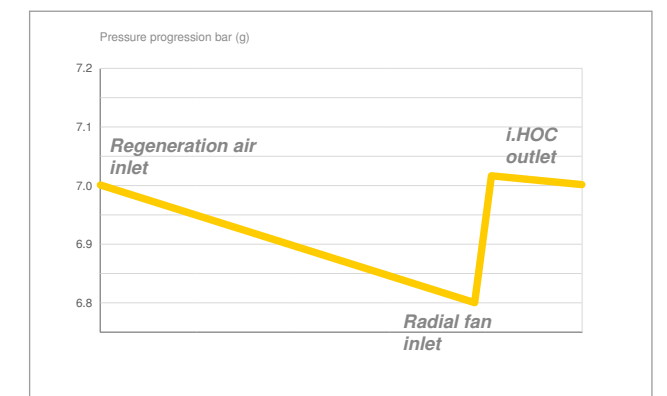

### Pressure loss? On the contrary!

The radial fan in the base of the rotation dryer equalises drying process pressure losses as needed, thereby guaranteeing maximum pressure dew point stability and quality – the pressure at the i.HOC dryer outlet is even higher than that at the inlet.



i.HOC

## Precision operation for high efficiency and low pressure dew points



### Precision drum

The silica gel desiccant is bedded in a precision-manufactured drum with exceptionally high run-out qualities. Incorrect flow within the dryer and the resulting pressure dew point fluctuations are therefore reliably prevented.



### Variable-speed drum motor

Drum speed is automatically adjusted according to actual compressor performance, so as to regenerate the desiccant as effectively as possible. This is the key to ensuring consistently low pressure dew points.



### Durable and efficient

The flow-optimised radial fan, which is integrated into the base of the dryer, efficiently compensates for pressure losses in the i.HOC's cooling path.



### External condensate separation

The i.HOC system uses a highly efficient condensate separator downstream from the heat exchanger in the second compression stage, so as to separate the condensate formed during the regeneration process **outside the dryer**. This protects the drum from potentially damaging water droplets.

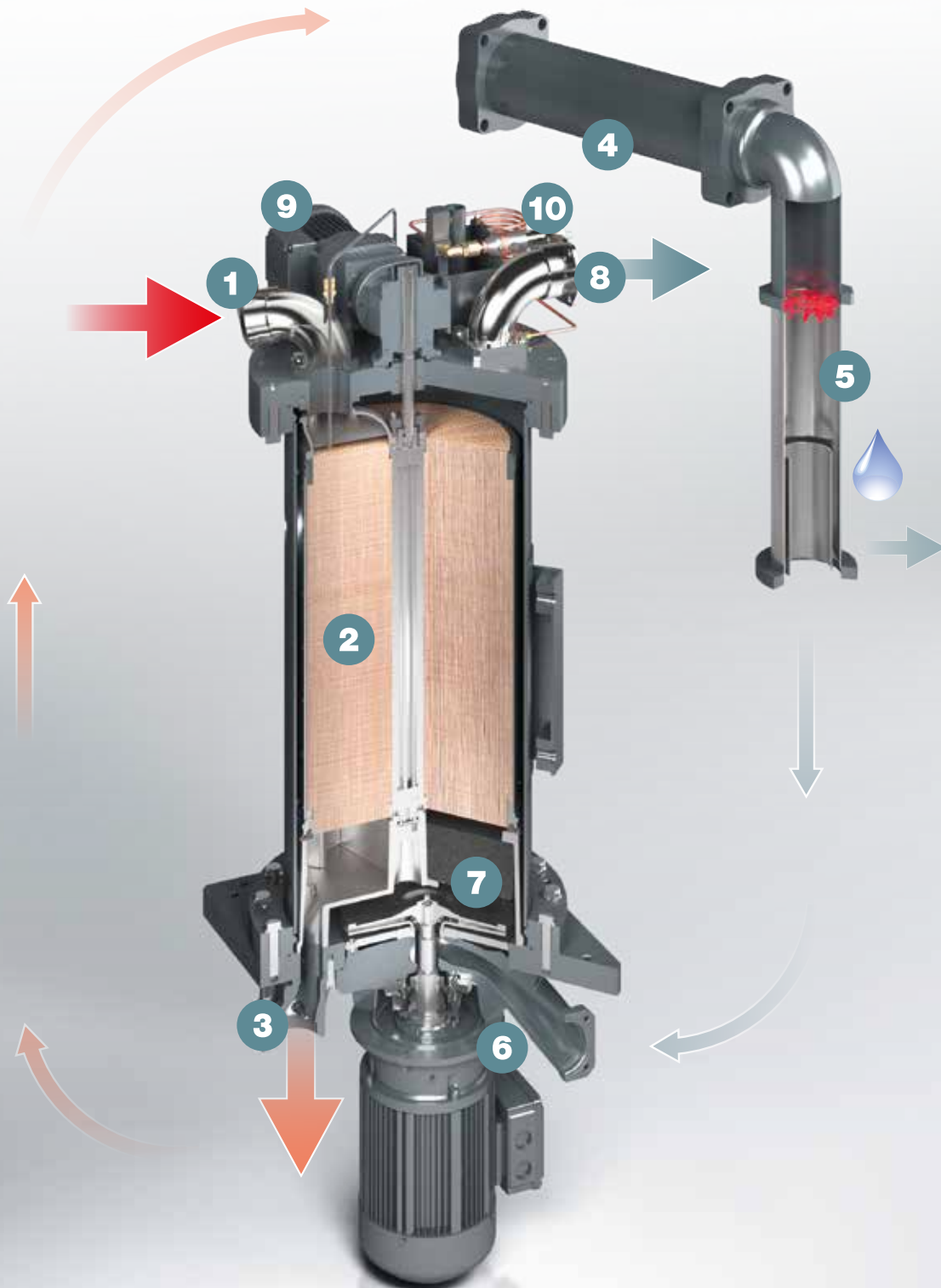

Image: RD 130 rotation dryer

- |                             |                                 |
|-----------------------------|---------------------------------|
| (1) Regeneration air inlet  | (6) Radial fan                  |
| (2) Drum                    | (7) Demister                    |
| (3) Regeneration air outlet | (8) i.HOC rotation dryer outlet |
| (4) Heat exchanger stage 2  | (9) Drum motor                  |
| (5) Condensate separator    | (10) Pressure dew point sensor  |

# Technical data – Air-cooled

## Standard versions

Model	Rated motor power kW	Gauge pressure bar	Standard			SFC with synchronous reluctance motor		
			Flow rate <sup>1)</sup> m³/min	Sound pressure level <sup>2)</sup> dB(A)	Weight kg	Flow rate <sup>1)</sup> m³/min	Sound pressure level <sup>2)</sup> dB(A)	Weight kg
CSG 60	37	6 8.6 11	6.84	69	2500	–	–	–
			5.63					
			4.74					
CSG 75	45	6 8.6 11	8.27	69	2550	4.07 - 8.31	70	2500
			7.14			4.04 - 7.02		
			6.14			–		
CSG 95	55	6 8.6 11	9.94	70	2550	4.78 - 9.83	71	2500
			8.82			4.76 - 8.75		
			7.51			4.74 - 7.85		
CSG 125	75	6 8.6 11	13.40	71	2550	5.27 - 13.35	72	2550
			12.30			5.25 - 11.94		
			11.35			4.96 - 10.61		
CSG 150	90	6 8.6 11	15.15	72	2800	5.28 - 16.09	73	2600
			14.58			5.25 - 14.51		
			13.49			5.23 - 13.29		



## Versions with add-on refrigeration dryer

Model	Rated motor power kW	Gauge pressure bar	Standard			SFC with synchronous reluctance motor		
			Flow rate <sup>1)</sup> m³/min	Sound pressure level <sup>2)</sup> dB(A)	Weight kg	Flow rate <sup>1)</sup> m³/min	Sound pressure level <sup>2)</sup> dB(A)	Weight kg
CSG 60	37	6 8.6 11	6.83	69	2700	–	–	–
			5.62					
			4.74					
CSG 75	45	6 8.6 11	8.25	69	2750	4.07 - 8.31	70	2700
			7.13			4.04 - 7.02		
			6.13			–		
CSG 95	55	6 8.6 11	9.92	70	2750	4.77 - 9.80	71	2700
			8.80			4.75 - 8.71		
			7.50			4.74 - 7.83		
CSG 125	75	6 8.6 11	13.37	71	2750	5.26 - 13.24	72	2750
			12.28			5.25 - 11.88		
			11.34			4.96 - 10.58		
CSG 150	90	6 8.6 11	–	72	3000	–	73	2800
			14.54			5.25 - 14.41		
			13.47			5.23 - 13.24		

## Versions with rotation dryer

Model	Rated motor power kW	Gauge pressure bar	Standard			SFC with synchronous reluctance motor		
			Flow rate <sup>1)</sup> m³/min	Sound pressure level <sup>2)</sup> dB(A)	Weight kg	Flow rate <sup>1)</sup> m³/min	Sound pressure level <sup>2)</sup> dB(A)	Weight kg
CSG 60	37	6 8.6 11	6.84	69	3200	–	–	–
			5.63					
			4.74					
CSG 75	45	6 8.6 11	8.27	69	3250	4.07 - 8.33	70	3200
			7.14			4.04 - 7.02		
			6.14			–		
CSG 95	55	6 8.6 11	9.94	70	3250	4.78 - 9.83	71	3200
			8.82			4.76 - 8.75		
			7.51			4.74 - 7.85		
CSG 125	75	6 8.6 11	13.40	71	3250	5.27 - 13.35	72	3200
			12.30			5.25 - 11.94		
			11.35			4.96 - 10.61		
CSG 150	90	6 8.6 11	–	72	3500	–	73	3300
			14.58			5.25 - 14.51		
			13.49			5.23 - 13.29		

## Dimensions

Standard / SFC W x D x H mm	With add-on refrigeration dryer / SFC W x D x H mm	With rotation dryer / SFC W x D x H mm
2200 x 1530 x 2125	2580 x 1530 x 2125	2900 x 1530 x 2125
		

<sup>1)</sup> Flow rate complete system as per ISO 1217: 2009, Annexe C/E, intake pressure 1 bar (a), cooling and inlet air temperature +20 °C, rel. humidity 0%  
<sup>2)</sup> Sound pressure level as per ISO 2151 and basic standard ISO 9614-2, tolerance: ± 3 dB (A)  
<sup>3)</sup> CSG 75 SFC: Version with rated motor power 55 kW

Specifications subject to change without notice.

<sup>1)</sup> Flow rate complete system as per ISO 1217: 2009, Annexe C/E, intake pressure 1 bar (a), cooling and inlet air temperature +20 °C, rel. humidity 0%  
<sup>2)</sup> Sound pressure level as per ISO 2151 and basic standard ISO 9614-2, tolerance: ± 3 dB (A)  
<sup>3)</sup> CSG 75 SFC: Version with rated motor power 55 kW

Specifications subject to change without notice.





# Technical data – Water-cooled

## Standard versions

Model	Rated motor power kW	Gauge pressure bar	Standard			SFC with synchronous reluctance motor		
			Flow rate <sup>1)</sup> m <sup>3</sup> /min	Sound pressure level <sup>2)</sup> dB(A)	Weight kg	Flow rate <sup>1)</sup> m <sup>3</sup> /min	Sound pressure level <sup>2)</sup> dB(A)	Weight kg
CSG 60	37	6 8.6 11	6.99	65	2500	–	–	–
			5.79					
			4.93					
CSG 75	45	6 8.6 11	8.41	66	2550	4.23 - 8.55	67	2500
			7.30			4.22 - 7.28		
			6.31			–		
CSG 95	55	6 8.6 11	10.08	67	2550	4.94 - 9.96	68	2500
			8.96			4.93 - 9.03		
			7.67			4.93 - 8.15		
CSG 125	75	6 8.6 11	13.55	68	2550	5.43 - 13.68	69	2550
			12.45			5.42 - 12.26		
			11.50			5.15 - 10.92		
CSG 150	90	6 8.6 11	15.30	69	2800	5.44 - 16.40	70	2600
			14.73			5.42 - 14.82		
			13.64			5.41 - 13.60		

## Dimensions

Standard / SFC W x D x H mm	With rotation dryer / SFC W x D x H mm
2200 x 1530 x 1960	2900 x 1530 x 1960
	

## Versions with rotation dryer

Model	Rated motor power kW	Gauge pressure bar	Standard			SFC with synchronous reluctance motor		
			Flow rate <sup>1)</sup> m <sup>3</sup> /min	Sound pressure level <sup>2)</sup> dB(A)	Weight kg	Flow rate <sup>1)</sup> m <sup>3</sup> /min	Sound pressure level <sup>2)</sup> dB(A)	Weight kg
CSG 60	37	6 8.6 11	6.99	65	3200	–	–	–
			5.79					
			4.93					
CSG 75	45	6 8.6 11	8.41	66	3250	4.23 - 8.55	67	3200
			7.30			4.22 - 7.28		
			6.31			–		
CSG 95	55	6 8.6 11	10.08	67	3250	4.94 - 9.96	68	3200
			8.96			4.93 - 9.03		
			7.67			4.93 - 8.15		
CSG 125	75	6 8.6 11	13.55	68	3250	5.43 - 13.68	69	3200
			12.45			5.42 - 12.26		
			11.50			5.15 - 10.92		
CSG 150	90	6 8.6 11	–	69	3500	–	70	3300
			14.73			5.42 - 14.82		
			13.64			5.41 - 13.60		

<sup>1)</sup> Flow rate complete system as per ISO 1217: 2009, Annexe C/E, intake pressure 1 bar (a), cooling and inlet air temperature +20 °C, rel. humidity 0%

<sup>2)</sup> Sound pressure level as per ISO 2151 and basic standard ISO 9614-2, tolerance: ± 3 dB (A)

<sup>3)</sup> CSG 75 SFC: Version with rated motor power 55 kW

Specifications subject to change without notice.

# Equipment

## Complete system

Dry compression rotary screw compressor with two-stage compression; axial centrifugal separator with safe condensate drainage and fibre-free pulsation damper downstream from both stages; ready for operation, fully automatic, soundproofed.

## Compressor airend

Two-stage, dry compression rotary screw compressor with integrated gearing and collection tank for gear oil; rotors with Sigma Profile and durable PEEK coating suitable for pharmaceuticals and food applications; high- and low-pressure stages with water jacket cooling for highest efficiency; patented sealing air system with oil tank ventilation; precision gears with gear quality according to ISO 1328 Class 5.

## Drive motors

Base load versions: Premium Efficiency drive motor (IE4), Peak load versions: Synchronous reluctance motor (IE5) with IES2 system efficiency, quality manufacture from SIEMENS; protection class IP 55, Pt100 temperature sensors in the stator windings and motor bearings; continuous measurement and monitoring of motor winding and bearing temperature, automatic grease lubrication.

## Electrical components

IP 54 control cabinet, cabinet ventilation; automatic star-delta contactor combination; overload relay, control transformer, cable entry feed optionally from “top” or “bottom”.

## SIGMA CONTROL 2

Full-text display, 30 selectable languages; soft-touch icon keys; “traffic light” style LEDs to indicate operating status; fully automatic monitoring and control; Dual, Quadro and Dynamic control modes selectable as standard; SD card for data logging and updates; RFID reader; web server; interfaces: Ethernet; optional communications modules for: Profibus DP, Modbus, Profinet and DeviceNet.

## Dynamic Control

The Dynamic Control feature calculates run-on times based on the motor winding temperature, which is measured by a sensor in the windings. This reduces idling times and cuts energy consumption. Additional control options are stored in the SIGMA CONTROL 2 and can be called up as required.

## Cooling

Air- or water-cooling available; radial fan with separate drive motor; exhaust air discharged upwards.

### Air-cooled version:

High-pressure side and low-pressure side: Aluminium cooler, high-pressure side: Implementation in the 11 bar version: Aluminium cooler with stainless steel tube pre-cooler, aluminium cooler for water jacket and gear oil.

### Water-cooled version:

Two shell and tube heat exchangers consisting of steel jacket (water side) and stainless-steel shell and tube (compressed air) with internal fins for optimised heat transfer, one plate-type heat exchanger each for water jacket and gear oil.

# Options

	Model	Air-cooled	Water-cooled
<b>Bolt-down machine feet</b>	CSG CSG T CSG i.HOC	●	●
<b>Cooling-air filter mats</b> (Protect the heat exchanger against heavy contamination)	CSG CSG T CSG i.HOC	●	–
<b>Integrated heat recovery with pump</b> (Compressor is equipped with a complete second auxiliary water system, including water pump. This protects the compressor against excessive temperatures.)	CSG CSG T CSG i.HOC	–	●
<b>Integrated heat recovery without pump</b> (Compressor is equipped with a second auxiliary water system, without water pump. This protects the compressor against excessive temperatures.)	CSG CSG T CSG i.HOC	–	●
<b>Auxiliary heat exchanger downstream from air cooler, 2nd stage</b> (Reduces the discharge temperature of compressed air in compressors with heat recovery. Improves the pressure dew point for compressors with i.HOC.)	CSG CSG T CSG i.HOC	–	●
<b>Integrated heat exchanger downstream from i.HOC rotation dryer</b> (Reduces the compressed air discharge temperature from the compressor in packages with integrated i.HOC.)	CSG i.HOC	●	●
<b>Standard vibration measurement and motor bearing temperature monitoring</b> (Monitoring of bearings on the motor and the compressor. Warning and fault levels are programmed in the controller.)	CSG CSG T CSG i.HOC	S	S
<b>Standard automatic motor bearing lubrication</b> (Drive motor bearings, with CSG i.HOC additionally for the fan motor bearings)	CSG CSG T CSG i.HOC	S	S
<b>Pressure dew point measurement</b> (Pressure dew point sensor standard on CSG i.HOC systems)	CSG i.HOC	S	S
<b>Pressure dew point control</b> (Pressure dew point measurement and controlled bypass around the stage 1 heat exchanger to improve pressure dew point as needed.)	CSG i.HOC	●	●
<b>KAESER hot air control</b> (Bypass around the stage 1 heat exchanger to increase compressed air temperature after leaving the 2nd stage, as needed. No heat exchanger installed downstream from the 2nd stage.)  <i>Not available for packages with integrated rotation or refrigeration dryer.</i>	CSG	●	●

- Available
- Not available
- S Available as part of standard equipment



**More compressed air for less energy**

# The world is our home

As one of the world's largest manufacturers of compressors, blowers and compressed air systems, KAESER KOMPRESSOREN is represented throughout the world by a comprehensive network of wholly owned subsidiaries and authorised distribution partners in over 140 countries.

By offering innovative, efficient and reliable products and services, KAESER KOMPRESSOREN's experienced consultants and engineers work in close partnership with customers to enhance their competitive edge and to develop progressive system concepts that continuously push the boundaries of performance and technology. Moreover, decades of knowledge and expertise from this industry-leading systems provider are made available to each and every customer via the KAESER group's advanced global IT network.

These advantages, coupled with KAESER's worldwide service organisation, ensure that every product operates at the peak of its performance at all times, providing optimal efficiency and maximum availability.



## **Kaeser Kompressoren (Thailand) Ltd.**

700/680 Moo 1 – Amata Nakorn Industrial Estate – Tambon Panthong – Amphur Panthong – Chonburi 20160

Phone: (+66) (0)38 447401-03 – Hotline: (+66) 89 9237377 – Fax: (+66) (0)38 447404

E-mail: [info.thailand@kaeser.com](mailto:info.thailand@kaeser.com) – [www.kaeser.com](http://www.kaeser.com)